

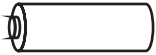

Questions, problems, missing parts?

Before returning to your retailer, call our customer service at 1-877-615-1378
Monday – Friday 8:00 a.m. – 4:00 p.m. EST

PACKAGE CONTENTS



Includes (1) AA Ni-Mh rechargeable battery per light.

LED: The lifetime for LEDs is estimated to be 100,000 hours.
It should never need to be replaced.

Ref. Part Name

- A Solar Gutter Light
- B Attachment Arm
- C Attachment Arm Screw
- D Thumb Screw
- E Wall Mount Screw

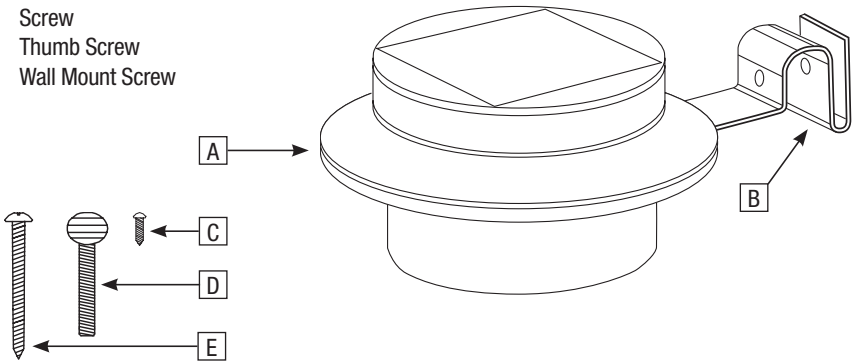

**⚠ Read all instructions before assembly.
Failure to do so may result in faulty assembly and potential injury.**

IMPORTANT INFORMATION

FUNCTION: The built-in solar panels convert sunlight into electricity. The rechargeable battery stores the energy and converts the power into light for use during the night. The lighting hours of the solar light depends on the geographical location and weather condition. Stronger or longer exposure to sunlight enables the battery to store more energy and provide longer lighting hours.

LOCATION: It is important to select an outdoor location with full, direct sunlight where the solar panel can receive at least 8 hours of sunlight each day. Shady areas will not enable batteries to be fully charged. This will reduce the lighting hours at night. It is also important to avoid placing the solar light by light sources, such as street lights or porch lights, which may cause the solar light to turn off automatically. The solar light is designated for outdoor usage and ideal for night lighting of garden, paths, etc.

CLEANING AND MAINTENANCE: Please use a damp cloth to clean the solar panel. Do not use any chemical or abrasive cleaner. It is important to ensure that no moisture enters into the solar light. Replacement parts may be ordered by using the fixture model number and part's name; call the phone number located at the top and bottom of this instruction manual.

RECHARGEABLE BATTERY: This product contains (1) AA Ni-Mh rechargeable battery. When the battery expires, it must be recycled or disposed of properly. Please contact your local waste disposal authority for correct procedure. Do not put battery into fire.

ASSEMBLY INSTRUCTIONS

GUTTER MOUNT ASSEMBLY (Figures 1 & 2)

- Gently remove all parts from the package and lay them out on a smooth surface.
- Insert the Attachment Arm (Part B) into the track on the housing of the Solar Gutter Light (Part A).
- Tighten the Attachment Arm Screw (Part C) to secure the Attachment Arm (Part B) to the Solar Gutter Light (Part A).
- Hook the Attachment Arm (Part B) over the edge of the gutter.
- Insert the Thumb Screw (Part D) into the hole at the end of the Attachment Arm (Part B). Firmly tighten the Thumb Screw (Part D) to secure to the gutter.

Figure 1

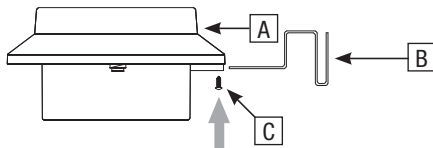
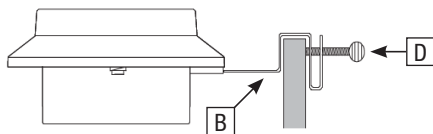

Figure 2



ASSEMBLY INSTRUCTIONS (continued)

WALL MOUNT ASSEMBLY (Figures 3 & 4)

- Gently remove all parts from the package and lay them out on a smooth surface.
- Position the flat folded end of the Attachment Arm (Part B) against the wall where you want to install the gutter light.
- Insert the Wall Mount Screw (Part E) into the hole opposite the flat end (opposite direction of when fixing to the gutter). Tighten until secure.
- Insert the Attachment Arm (Part B) into the track on the housing of the Solar Gutter Light (Part A).
- Tighten the Attachment Arm Screw (Part C) to secure the Attachment Arm (Part B) to the Solar Gutter Light (Part A).

Figure 3

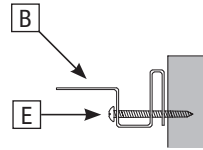
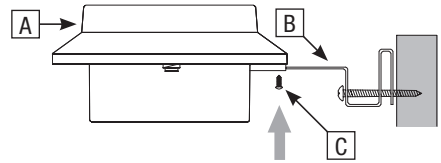

Figure 4



OPERATIONAL INSTRUCTIONS AND BATTERY REPLACEMENT

OPERATION (Figure 5)

- After assembling, take the light to direct sunshine that allows the rechargeable battery to reach its maximum capacity.
- Slide the ON/OFF switch to the ON position. Ensure the light is in full sunlight for 8 hours.
- The unit will then automatically light up at dusk.

Note: Lights with crystalline panels may have a protective film over the solar panel. This must be removed prior to use.

Figure 5

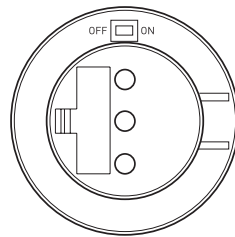

CHANGING THE BATTERY (Figures 5 & 6)

- Slide the ON/OFF switch to the OFF position.
- Open the battery chamber cover.
- Replace the battery with a new AA Ni-Mh solar rechargeable battery, ensuring the correct polarity is observed.
- Reassemble the unit by reversing the above procedure.
- Slide the ON/OFF switch to the ON position. Fully charge the battery before first use for up to 2 days in full sunlight in the ON position. The unit will then automatically light up at dusk.

Figure 6

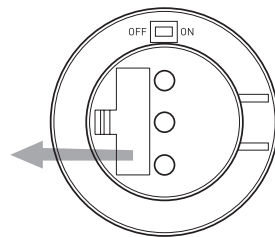

TROUBLESHOOTING

The light does not come on at night:

- Make sure the ON/OFF switch is in the ON position.
- Check the rechargeable battery and make sure that it is in contact to the metal plate and the polarity is correct. If the battery is worn out, replace the battery with a AA Ni-Mh rechargeable battery.
- Always keep the solar light distant from other night light sources, such as exterior lights. Reposition the light to avoid close contact with other night light sources.
- Make sure solar panel is clean and free of dirt and debris. If needed use a damp cloth to clean the solar panel. Do not use any chemical or abrasive cleaner. It is important to ensure that no moisture enters into the solar light.

ONE-YEAR LIMITED WARRANTY: If, during normal use, this PATRIOT LIGHTING® lighting fixture breaks or fails due to a defect in material and workmanship within (1) year from the date of original purchase, simply bring this lighting fixture with the original sales receipt back to your nearest MENARDS® retail store. At its discretion, PATRIOT LIGHTING® agrees to have the product or any defective part(s) repaired or replaced with the same or similar PATRIOT LIGHTING® product or part free of charge, within the stated warranty period, when returned by the original purchaser with original sales receipt. This warranty; (1) excludes expendable parts including but not limited to light bulbs and batteries; (2) does not cover damage that resulted from abuse or misuse; and (3) does not cover any losses, labour, injuries to persons/property or costs. This warranty does give you specific legal rights and you may have other rights, which vary from state to state.



Questions, problems, missing parts?

Before returning to your retailer, call our customer service at
1-877-615-1378 Monday – Friday 8:00 a.m. – 4:00 p.m. EST